

# Bauteile AR-15

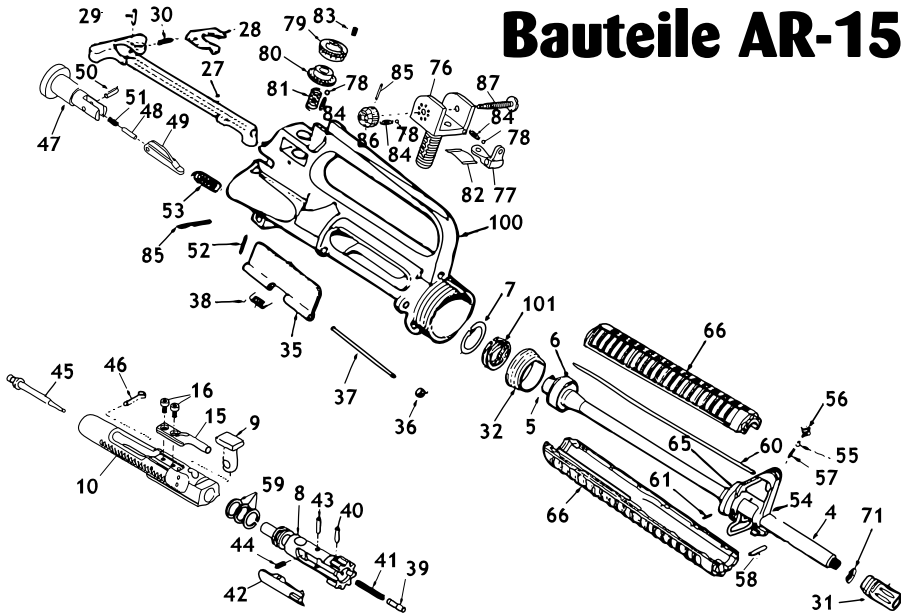

- Nr. Artikel
- 4 Barrel
- 5 Barrel Extension
- 6 Barrel Nut
- 7 Barrel Retaining Ring
- 8 Bolt
- 9 Bolt Cam Pin
- 10 Bolt Carrier
- 15 Bolt Key
- 16 Bolt Key Screw
- 27 Charging Handle
- 28 Charging Handle Latch
- 29 Charging Handle Latch Pin

- 30 Charging Handle Latch Spring
- 31 Compensator
- 32 Delta Ring
- 35 Ejection Port Cover
- 36 Ejection Port Cover Hinge Pin Snap Ring
- 37 Ejection Port Cover Pin
- 38 Ejection Port Cover Spring
- 39 Ejector
- 40 Ejector Pin
- 41 Ejector Spring
- 42 Extractor
- 43 Extractor Pin
- 44 Extractor Spring

- 45 Firing Pin
- 46 Firing Pin Retaining Pin
- 47 Forward Assist
- 48 Forward Assist Detent
- 49 Forward Assist Pawl
- 50 Forward Assist Pawl Roll Pin
- 51 Forward Assist Pawl Roll Spring
- 52 Forward Assist Pin
- 53 Forward Assist Spring
- 54 Front Sight Base
- 55 Front Sight Detent
- 56 Front Sight Post
- 57 Front Sight Spring
- 58 Front Sight Taper Pin
- Nr. Artikel
- 59 Gas Ring
- 60 Gas Tube
- 61 Gas Tube Roll Pin
- 65 Handguard Cap
- 66 Handguard Set
- 71 Peel/Crush Washer
- 76 Rear Sight Base
- 77 Rear Sight Base Aperture
- 78 Rear Sight Base Ball Bearing
- 79 Rear Sight Base Elevation Index
- 80 Rear Sight Base Elevation Knob
- 81 Rear Sight Base Elevation Knob Spring
- 82 Rear Sight Base Flat Spring
- 83 Rear Sight Base Index Screw
- 84 Rear Sight Base Spring
- 85 Rear Sight Base Spring Pin
- 86 Rear Sight Base Windage Knob
- 87 Rear Sight Base Windage Knob Screw
- 100 Upper Receiver
- 101 Weld Spring
- Gas Block
- Upper Assembly

- Nr. Artikel
- 1 Access Door Assembly
- 2 Access Door Hinge
- 3 Access Door Hinge Pin
- 11 Bolt Catch
- 12 Bolt Catch Plunger
- 13 Bolt Catch Roll Spring
- 14 Bolt Catch Spring
- 17 Buffer
- 18 Buffer Retainer
- 19 Buffer Retainer Spring
- 20 Buffer Spring
- 21 Buffer Tube
- 22 Buttplates & Recoil Pads
- 23 Buttstock
- 24 Buttstock Screw Lower
- 25 Buttstock Screw Upper
- 26 Buttstock Spacer
- 33 Disconnecter
- 34 Disconnecter Spring
- 62 Hammer
- 63 Hammer Pin
- 64 Hammer Spring
- 67 Lower Receiver
- 68 Magazine Release
- 69 Magazine Release Button
- 70 Magazine Release Spring
- 72 Pistol Grip
- 73 Pistol Grip Lock Washer
- 74 Pistol Grip Screw
- 75 Pivot Pin
- 88 Rear Swivel
- 89 Selector
- 90 Selector Detent
- 91 Selector Detent Spring

- Nr. Artikel
- 92 Takedown Detent
- 93 Takedown Detent Spring (Front & Rear)
- 94 Takedown Pin
- 95 Trigger
- 96 Trigger Guard
- 97 Trigger Guard Roll Pin
- 98 Trigger Pin
- 99 Trigger Spring

**Anhand der  
Teilenummer in der Zeichnung  
finden Sie Ihr Waffenteil ganz  
leicht auf den folgenden Seiten.**

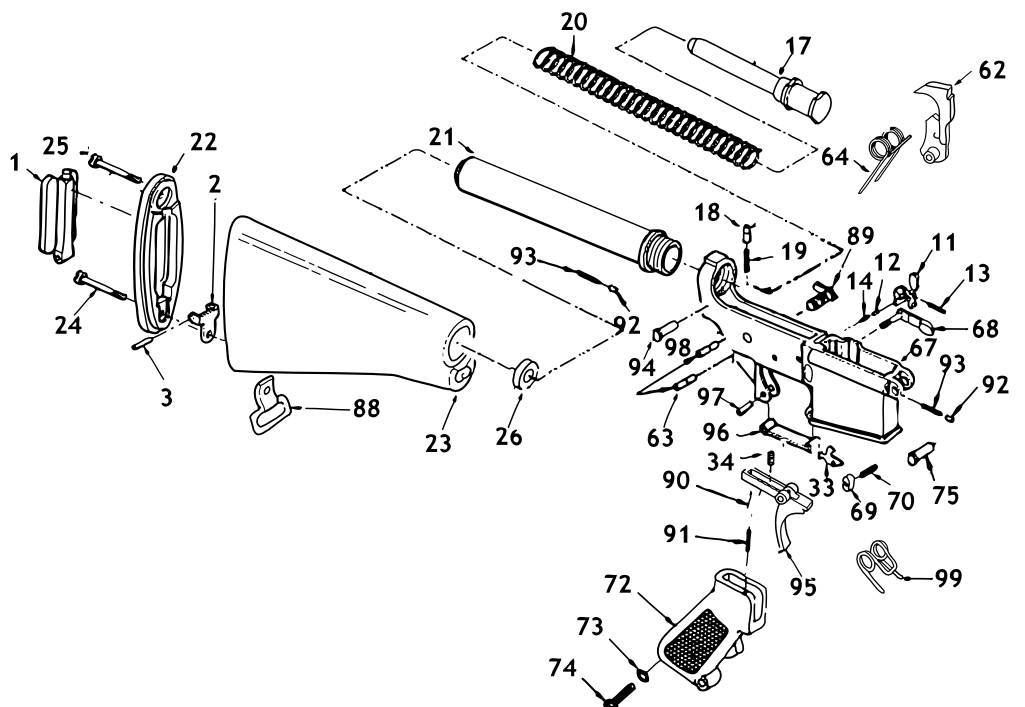

Verkauf von Läufen, kompletten Verschlüssen und Verschlussköpfen nur gegen Erwerbsberechtigung (grüne WBK mit Eintrag der Basiswaffe oder gültiger Jahresjagdschein); Läufe unter 16,75" (42,5cm) werden nur an Inhaber eines gültigen Jahresjagdscheins verkauft, für den Erwerb dieser „kurzen“ Läufe reicht eine grüne WBK nicht aus.

# Zeichnung	Art.-Nr.	Beschreibung	Preis
1	AR00101	DPMS Access Door Assembly	<b>29,90</b>
2	AR00202	DPMS Access Door Hinge	<b>4,40</b>
3	AR00303	DPMS Access Door Hinge Pin	<b>3,80</b>
Alle Läufe, Systemgehäuse, Verschlussköpfe und Verschlüsse komplett zzgl. Kosten für Einbau und staatl. Beschuss*. Festbestellung!			
4	AR00404	AR-Stoner Lauf AR-15 .223 Rem, SDM-R Kontur, 8" Dralllänge, 20" Lauflänge, geflutet, Stainless Steel	<b>*469,00</b>
	AR00405	AR-Stoner Lauf AR-15 .223 Rem, HBAR Kontur, 8" Dralllänge, 20" Lauflänge, Stainless Steel	<b>*409,00</b>
	AR00406	AR-Stoner Lauf AR-15 .223 Rem, Medium Kontur, 8" Dralllänge, 18" Lauflänge, geflutet, Stainless Steel	<b>*479,00</b>
	AR00407	DPMS Lauf AR-15 .223 Rem, .920" Mündungsdurchmesser, 8" Dralllänge, 24" Lauflänge, geflutet, Stainless Steel mit Stahl-Gas-Block	<b>*449,00</b>
	AR00408	DPMS Lauf AR-15 .223 Rem, .920" Mündungsdurchmesser, 8" Dralllänge, 24" Lauflänge, Stainless Steel mit Alu-Gas-Block	<b>*379,00</b>
	AR00409	DPMS Lauf AR-15 .223 Rem, .920" Mündungsdurchmesser, 9" Dralllänge, 20" Lauflänge, Stainless Steel mit Alu-Gas-Block	<b>*349,00</b>
	AR00410	DPMS Lauf AR-15 .223 Rem, .920" Mündungsdurchmesser, 9" Dralllänge, 24" Lauflänge, geflutet, Stainless Steel mit Stahl-Gas-Block	<b>*489,00</b>
	AR00411	DPMS Lauf AR-15 .223 Rem DCM Heavy Barrel, 8" Dralllänge, 20" Lauflänge, Stainless Steel mit Visier	<b>*459,00</b>
	AR00412	DPMS Lauf AR-15 .223 Rem DCM Heavy Barrel, 8" Dralllänge, 20" Lauflänge, Stainless Steel mit Visier „Pre-Ban“	<b>*459,00</b>
	AR00413	Krieger Lauf AR-15 .223 Rem .920" Mündungsdurchmesser, 7,7" Dralllänge, 26" Lauflänge, Stainless Steel	<b>*1059,00</b>
	AR00414	Krieger Lauf AR-15 .223 Rem .920" Mündungsdurchmesser, 9" Dralllänge, 26" Lauflänge, Stainless Steel	<b>*1059,00</b>
	AR00415	Krieger Lauf AR-15 .223 Rem DCM Kontur 1, 7,7" Dralllänge, 20" Lauflänge, Stainless Steel	<b>*949,00</b>
	AR00416	Olympic Lauf AR-15 .223 Rem, M4 Kontur, 9" Dralllänge, 16" Lauflänge, Stainless Steel mattschwarz, mit Visier „Pre-Ban“	<b>*424,00</b>
	AR00417	Olympic Lauf AR-15 .223 Rem Lightweight Kontur, 9" Dralllänge, 16" Lauflänge, Chrom Moly Stahl, mattschwarz, mit Visier „Pre-Ban“	<b>*424,00</b>

# Zeichnung	Art.-Nr.	Beschreibung	Preis
	AR00418	Olympic Lauf AR-15 .223 Rem Heavy Kontur, 9" Dralllänge, 16" Lauflänge, Chrom Moly Stahl, mattschwarz, mit Visier „Pre-Ban“	<b>*359,00</b>
	AR00419	Olympic Lauf AR-15 .223 Rem Heavy Kontur, 9" Dralllänge, 20" Lauflänge, Chrome Moly Stahl, mattschwarz, mit Visier „Pre-Ban“	<b>*424,00</b>
	AR00420	Olympic Lauf AR-15 .223 Rem, .920" Mündungsdurchmesser, 9" Dralllänge, 24" Lauflänge, Chrom Moly Stahl, mattschwarz	<b>*479,00</b>
	AR00421	Olympic Ultra Match Lauf AR-15 .223 Rem, Heavy Kontur, 10" Dralllänge, 24" Lauflänge, Stainless Steel, mattschwarz	<b>*659,00</b>
	AR00422	Olympic Ultra Match Lauf AR-15 .223 Rem, .920" Mündungsdurchmesser, 10" Dralllänge, 16" Lauflänge, Stainless Steel, mattschwarz	<b>*628,00</b>
	AR00423	Olympic Ultra Match Lauf AR-15 .223 Rem, .920" Mündungsdurchmesser, 10" Dralllänge, 20" Lauflänge, Stainless Steel, mattschwarz	<b>*598,00</b>
	AR00424	Olympic Ultra Match Lauf AR-15 .223 Rem, .920" Mündungsdurchmesser, 10" Dralllänge, 24" Lauflänge, Stainless Steel, mattschwarz	<b>*698,00</b>
			
5	AR00525	DPMS Barrel Extension, TiN beschichtet	<b>52,70</b>
	AR00526	DPMS Barrel Extension, Stainless Steel	<b>39,50</b>
	AR00527	LesBear Barrel Extension, Stahl blank	<b>49,90</b>
6	AR00628	DPMS Barrel Nut, mattschwarz	<b>13,90</b>
	AR00629	Olympic Barrel Nut, mattschwarz	<b>32,50</b>
7	AR00730	DPMS Barrel Snap Ring	<b>3,40</b>
	AR00731	Olympic Barrel Snap Ring	<b>3,70</b>
8	AR00832	DPMS Bolt (Verschlusskopf einzeln), mattschwarz	<b>*74,95</b>
	AR00833	DPMS Bolt Assembly (Verschlusskopf komplett, incl. 39-44, 59), mattschwarz	<b>*81,90</b>
			
	AR00834	LesBear Bolt Assembly (Verschlusskopf komplett, incl. 39-44, 59), mattschwarz	<b>*149,90</b>
	AR00835	Olympic Bolt Assembly (Verschlusskopf komplett, incl. 39-44, 59), mattschwarz	<b>*117,50</b>
9	AR00936	DPMS Bolt Cam Pin, mattschwarz	<b>7,90</b>
			
	AR00937	DPMS Bolt Cam Pin, TiN beschichtet	<b>24,90</b>
			
10	AR01038	DPMS Bolt Carrier, mattschwarz	<b>111,90</b>
	AR01039	DPMS Bolt Carrier, TiN beschichtet	<b>159,90</b>
	AR01040	Olympic Bolt Carrier, mattschwarz	<b>114,50</b>
	AR01041	DPMS Bolt Carrier mit Key und Schrauben (10, 15, 16), mattschwarz	<b>139,90</b>
	AR01042	LesBear Bolt Carrier mit Key und Schrauben (10, 15, 16), mattschwarz	<b>189,00</b>

# Zeichnung	Art.-Nr.	Beschreibung	Preis
11	AR01143	DPMS Bolt Catch, Chrom	<b>23,90</b>
	AR01144	DPMS Bolt Catch, mattschwarz	<b>11,30</b>



	AR01145	MagPul BAD Bolt Catch mit verlängertem Drücker, mattschwarz	<b>45,00</b>
	AR01146	Olympic Bolt Catch	<b>16,90</b>
12	AR01247	DPMS Bolt Catch Plunger, mattschwarz	<b>3,40</b>
	AR01248	Olympic Bolt Catch Plunger, mattschwarz	<b>3,70</b>
13	AR01349	DPMS Bolt Catch Roll Pin	<b>3,00</b>
	AR01350	Olympic Bolt Catch Roll Pin	<b>3,50</b>
14	AR01451	DPMS Bolt Catch Spring	<b>3,00</b>
	AR01452	Olympic Bolt Catch Spring	<b>3,50</b>
15	AR01553	DPMS Bolt Carrier Key, mattschwarz	<b>23,90</b>
	AR01554	DPMS Bolt Carrier Key, Tin beschichtet	<b>36,90</b>
	AR01555	Olympic Bolt Carrier Key, mattschwarz	<b>26,90</b>
16	AR01656	DPMS Bolt Carrier Key Screw, mattschwarz	<b>2,80</b>
	AR01657	Olympic Bolt Carrier Key Screw, mattschwarz	<b>3,50</b>
17	AR01758	DPMS Buffer .223 Rem	<b>19,40</b>
	AR01759	Mako Buffer .223 Rem	<b>12,90</b>
18	AR01860	DPMS Buffer Retainer, mattschwarz	<b>3,70</b>
	AR01861	Olympic Buffer Retainer, mattschwarz	<b>5,40</b>
19	AR01962	DPMS Buffer Retainer Spring	<b>2,80</b>
	AR01963	Olympic Buffer Retainer Spring	<b>3,50</b>
20	AR02064	DPMS Buffer Spring	<b>8,10</b>
	AR02065	Mako Buffer Spring	<b>6,90</b>
21	AR02166	Vltor Buffer Tube, 5-pos. Mil Spec Diameter 1,148"	<b>75,95</b>
	AR02167	DPMS Buffer Tube, A1/A2 für starre Schäfte	<b>27,20</b>
	AR02168	Advanced Tec. Buffer Tube, 6-pos. Commercial Diameter 1.168"	<b>58,50</b>
22	AR02269	ACE Modular Schaftkappe, 1", schwarz	<b>19,50</b>
	AR02270	Advanced Tec. Kappe für M4 oder Shortforce Schäfte 1", schwarz	<b>21,00</b>
	AR02271	John Masen Schaftkappe A2 Schaft mit Klappe	<b>24,90</b>
	AR02272	ProMag M4 Carbine Schaftkappe mit „US“ Logo 1/2", schwarz	<b>13,50</b>



23	AR02373	Bell & Carlson Schaft mit Daumenloch, schwarz	<b>185,00</b>
	AR02374	Olympic Schaft AR-15 A2 komplett mit Buffer und Feder	<b>165,00</b>
	AR02375	DPMS Schaft AR-15 A2 komplett mit Buffer und Feder	<b>159,00</b>
24	AR02476	DPMS A2 Lower Schraube	<b>3,90</b>
	AR02477	DPMS A1 Lower Schraube	<b>7,40</b>
	AR02478	Olympic Lower Schaftschraube	<b>5,40</b>
25	AR02579	DPMS A2 Upper Schraube	<b>4,50</b>
	AR02580	DPMS A1 Upper Schraube	<b>4,50</b>
26	AR02681	Olympic Schaft Spacer	<b>5,40</b>
27	AR02782	DPMS Charging Handle solo, mattschwarz	<b>18,50</b>
28	AR02883	DPMS Charging Handle Latch Standard, mattschwarz	<b>4,90</b>

# Zeichnung	Art.-Nr.	Beschreibung	Preis
	AR02884	Olympic Charging Handle Latch Standard, mattschwarz	<b>14,90</b>



	AR02885	Badger Ordnance Tactical Charging Handle Latch extra groß, mattschwarz	<b>28,90</b>
--	---------	--	--------------



	AR02886	Badger Ordnance Tactical Gen2 Charging Handle Latch ext., mattschwarz	<b>28,90</b>
--	---------	---	--------------



	AR02887	PRI Combat Charging Handle Latch Alu, mattschwarz	<b>3,50</b>
--	---------	---	-------------

29	AR02988	DPMS Charging Handle Latch Pin	<b>2,80</b>
----	---------	--------------------------------	-------------

	AR02989	Olympic Charging Handle Latch Pin	<b>3,50</b>
--	---------	-----------------------------------	-------------

30	AR03090	DPMS Charging Handle Latch Feder	<b>3,00</b>
----	---------	----------------------------------	-------------

	AR03091	Olympic Charging Handle Latch Feder	<b>3,50</b>
--	---------	-------------------------------------	-------------

27-30	AR02791	DPMS Charging Handle komplett Standard, mattschwarz	<b>37,50</b>
-------	---------	---	--------------



	AR02792	Model 1 Tactial Latch Charging Handle komplett, mattschwarz	<b>49,90</b>
--	---------	---	--------------



	AR02793	PRI Gas Buster Charging Handle Latch komplett, mattschwarz	<b>156,80</b>
--	---------	--	---------------

Alle Mündungsbremsen haben das Gewinde 1/2"-28, falls nichts anderes vermerkt



31	AR03194	Arredondo NxG Muzzle Break, mattschwarz	<b>199,00</b>
----	---------	---	---------------

	AR03195	Arredondo NxG Muzzle Break, Stainless Steel	<b>199,00</b>
--	---------	---	---------------



	AR03196	DPMS Branson Muzzle Break, mattschwarz	<b>61,90</b>
--	---------	--	--------------

	AR03197	DPMS Panther Kompensator, mattschwarz	<b>35,20</b>
--	---------	---------------------------------------	--------------



	AR03198	JP Enterprises Bennie Cooley Tactical Muzzle Break 0.875", Stainless Steel	<b>149,90</b>
--	---------	--	---------------

	AR03199	JP Enterprises Bennie Cooley Tactical Muzzle Break 0.925", Stainless Steel	<b>149,90</b>
--	---------	--	---------------

# Zeichnung	Art.-Nr.	Beschreibung	Preis
	<b>AR03100</b>	JP Enterprises Bennie Cooley Tactical Muzzle Break 0.925", mattschwarz	<b>149,90</b>
			
	<b>AR03101</b>	JP Enterprises Recoil Eliminator Muzzle Break 3/4" Taper, mattschwarz	<b>149,90</b>
	<b>AR03102</b>	JP Enterprises Recoil Eliminator Muzzle Break 3/4" Taper, Stainless Steel	<b>166,90</b>
			
	<b>AR03103</b>	Yankee Hill Machine Muzzle Break 5M1 Aggressive	<b>49,90</b>
32	<b>AR03204</b>	DPMS Delta Ring	<b>12,40</b>
	<b>AR03205</b>	Olympic Delta Ring	<b>25,60</b>
	<b>AR03206</b>	DPMS Delta Ring Pack (7, 32, 101)	<b>39,50</b>
	<b>AR03207</b>	Olympic Delta Ring Pack (7,32,101)	<b>39,50</b>
33	<b>AR03308</b>	DPMS Disconnecter, mattschwarz	<b>8,10</b>
	<b>AR03309</b>	DPMS Disconnecter, Tin Coated	<b>27,90</b>
	<b>AR03310</b>	Olympic Disconnecter, mattschwarz	<b>12,30</b>
34	<b>AR03411</b>	DPMS Disconnecter Spring	<b>3,20</b>
	<b>AR03412</b>	Olympic Disconnecter Spring	<b>3,50</b>
35	<b>AR03513</b>	DPMS Ejection Port Cover, Chrome	<b>18,30</b>
	<b>AR03514</b>	DPMS Ejection Port Cover, mattschwarz	<b>7,90</b>
	<b>AR03515</b>	Olympic Ejection Port Cover, mattschwarz	<b>25,10</b>
36	<b>AR03616</b>	DMPS Ejection Port Cover Hinge Pin Snap Ring	<b>3,00</b>
37	<b>AR03717</b>	DMPS Ejection Port Cover Pin, Chrome	<b>13,70</b>
	<b>AR03718</b>	DMPS Ejection Port Cover, mattschwarz	<b>3,50</b>
	<b>AR03719</b>	Olympic Ejection Port Cover, mattschwarz	<b>3,70</b>
38	<b>AR03820</b>	DMPS Ejection Port Cover Spring, silber	<b>3,00</b>
	<b>AR03821</b>	Olympic Ejection Port Cover Spring, mattschwarz	<b>3,70</b>
35-38	<b>AR03522</b>	DPMS Ejection port cover Kit	<b>10,10</b>
39	<b>AR03923</b>	Olympic Ejector, mattschwarz	<b>9,00</b>
40	<b>AR04024</b>	DPMS Ejector Pin, mattschwarz	<b>2,80</b>
	<b>AR04025</b>	Olympic Ejector Pin, mattschwarz	<b>3,50</b>
42	<b>AR04228</b>	DPMS Extractor, Chrome	<b>24,30</b>
	<b>AR04229</b>	DPMS Extractor, mattschwarz	<b>24,90</b>
43	<b>AR04330</b>	DPMS Extractor Pin, mattschwarz	<b>3,40</b>
	<b>AR04331</b>	Olympic Extractor Pin, mattschwarz	<b>3,60</b>
44	<b>AR04432</b>	DPMS Extractor Spring, mattschwarz	<b>3,40</b>
	<b>AR04433</b>	Olympic Extractor Spring, mattschwarz	<b>3,70</b>
	<b>AR04434</b>	DPMS Bolt Maintenance Kit (39-44, 3x 59)	<b>33,30</b>
45	<b>AR04535</b>	DPMS Firing Pin, Stainless Steel	<b>11,20</b>
	<b>AR04536</b>	Olympic Firing Pin, mattschwarz	<b>9,90</b>
46	<b>AR04637</b>	DPMS Firing Pin Retaining Pin, mattschwarz	<b>3,20</b>
	<b>AR04638</b>	Olympic Firing Pin Retaining Pin, mattschwarz	<b>3,50</b>
47	<b>AR04739</b>	DPMS Forward Assist rund komplett (47-51), Chrome	<b>25,30</b>
	<b>AR04740</b>	DPMS Forward Assist komplett (47-51), mattschwarz	<b>22,90</b>
	<b>AR04741</b>	Olympic Forward Assist rund komplett (47-51), mattschwarz	<b>27,90</b>







# Zeichnung	Art.-Nr.	Beschreibung	Preis
48	<b>AR04842</b>	DPMS Forward Assist Detent, mattschwarz	<b>3,40</b>
49	<b>AR04943</b>	DPMS Forward Assist Pawl, mattschwarz	<b>7,90</b>
50	<b>AR05044</b>	DPMS Forward Assist Pawl Roll Pin	<b>3,20</b>
51	<b>AR05145</b>	DPMS Forward Assist Pawl Spring	<b>3,20</b>
52	<b>AR05246</b>	DPMS Forward Assist Roll Pin	<b>3,00</b>
	<b>AR05247</b>	Olympic Forward Assist Roll Pin	<b>3,50</b>
53	<b>AR05348</b>	DPMS Forward Assist Spring	<b>3,00</b>
	<b>AR05349</b>	Olympic Forward Assist Spring	<b>3,50</b>
54	<b>AR05450</b>	DPMS Front Sight Base, mattschwarz	<b>51,70</b>
55	<b>AR05551</b>	DPMS Front Sight Detent, mattschwarz	<b>3,40</b>
	<b>AR05552</b>	Olympic Front Sight Detent, mattschwarz	<b>6,90</b>
56	<b>AR05653</b>	DPMS A1 Front Sight Post Round Style, mattschwarz	<b>5,50</b>







			
	<b>AR05654</b>	DPMS A2 Front Sight Post Square Style, mattschwarz	<b>6,90</b>
	<b>AR05655</b>	DPMS Front Sight Post National Match Style 0.050" Round, mattschwarz	<b>14,80</b>

			
	<b>AR05656</b>	KNS Front Sight Post Duplex Crosshair, mattschwarz	<b>46,80</b>



			
	<b>AR05657</b>	Mounting Solutions Plus Front Match Sight Post 0.030" (Fiber Optic)	<b>85,90</b>
	<b>AR05658</b>	Mounting Solutions Plus Front Sight Post 0.040" (Fiber Optic)	<b>85,90</b>

57	<b>AR05759</b>	DPMS Front Sight Detent Spring	<b>2,80</b>
	<b>AR05760</b>	Olympic Front Sight Detent Spring	<b>4,20</b>
58	<b>AR05861</b>	DPMS Front Sight Taper Pin	<b>3,40</b>
	<b>AR05862</b>	DPMS Front Sight Oversize Taper Pin	<b>3,40</b>
	<b>AR05863</b>	Olympic Front Sight Taper Pin	<b>3,70</b>
59	<b>AR05964</b>	DPMS Gas Ring (1 Stück)	<b>3,00</b>
	<b>AR05965</b>	DPMS Gas Ring McFarland 1-teilig	<b>7,10</b>
	<b>AR05966</b>	Olympic Gas Ring (3 Stück)	<b>7,10</b>
	<b>AR05967</b>	Olympic Gas Ring 1-teilig	<b>12,50</b>
60	<b>AR06068</b>	DPMS Gas Tube 7" Pistol length	<b>22,90</b>
	<b>AR06069</b>	DPMS Gas Tube Carbine length (9,3/4")	<b>23,30</b>
	<b>AR06070</b>	DPMS Gas Tube Rifle length (15 3/16")	<b>22,90</b>
	<b>AR06071</b>	Olympic Gas Tube Carbine length (9 3/4")	<b>30,90</b>
	<b>AR06072</b>	Olympic Gas Tube Rifle length (15 3/16")	<b>36,20</b>
	<b>AR06073</b>	Yankee Hill Gas Tube Carbine length (9 3/4")	<b>32,30</b>
	<b>AR06074</b>	Yankee Hill Gas Tube Rifle length (15 3/16")	<b>32,30</b>
61	<b>AR06175</b>	DPMS Gas Tube Pin	<b>3,00</b>
62	<b>AR06276</b>	DPMS Hammer chrome small pin 0.154	<b>45,50</b>







# Zeichnung	Art.-Nr.	Beschreibung	Preis
	AR06277	DPMS Hammer mattschwarz small pin 0.154"	<b>36,10</b>
	AR06278	DPMS Hammer TiN Coated small pin 0.154"	<b>61,70</b>
	AR06279	DPMS Hammer mattschwarz large pin 0.174"	<b>64,80</b>
	AR06280	JP Enterprises Speed Hammer small pin 0.154"	<b>78,90</b>
	AR06281	JP Enterprises Speed Hammer large pin 0.174"	<b>78,90</b>
63	AR06382	DPMS Hammer and Trigger Pin small 0.154"	<b>7,10</b>
	AR06383	DPMS Hammer and Trigger Pin large 0.174"	<b>6,30</b>
			
	AR06384	DPMS Anti Walk Hammer and Trigger small Pin 0,154"	<b>12,95</b>
			
	AR06385	JP Enterprises Anti-Walk Trigger and Hammer small pin 0.154"	<b>16,95</b>
	AR06386	JP Enterprises Anti-Walk Trigger and Hammer large pin 0.174"	<b>15,90</b>
64	AR06487	DPMS Hammer Spring	<b>3,40</b>
	AR06488	Olympic Hammer Spring	<b>3,70</b>
65	AR06589	DPMS Handguard Cap Round, mattschwarz	<b>4,70</b>
	AR06590	DPMS Handguard Cap Triangle, mattschwarz	<b>4,70</b>
	AR06591	Olympic Handguard Cap Round, mattschwarz	<b>12,90</b>
	AR06592	Olympic Handguard Cap Triangle, mattschwarz	<b>12,90</b>
			
66	AR06693	DPMS Free Float Tube Quad Rail, Carbine Länge, mattschwarz	<b>284,50</b>
	AR06694	DPMS Free Float Tube Quad Rail, Rifle Länge, mattschwarz	<b>289,90</b>
			
	AR06695	DPMS Free Float Tube DCM Competition, Rifle Länge, mattschwarz	<b>264,00</b>
	AR06696	DPMS Free Float Tube Vented Round, Carbine Länge, mattschwarz	<b>165,00</b>
	AR06697	DPMS Free Float Tube Vented Round, Rifle Länge, mattschwarz	<b>110,60</b>
	AR06698	Yankee Hill Free Float Tube Smooth Quad Rail, Carbine Länge, mattschwarz	<b>205,00</b>
			
	AR06699	Yankee Hill Free Float Tube Smooth Quad Rail, Rifle Länge, mattschwarz	<b>261,40</b>
			
67	AR06700	DPMS Lower Receiver ohne Innenteile solo, mattschwarz	<b>279,00</b>

# Zeichnung	Art.-Nr.	Beschreibung	Preis
			
	AR06701	CMMG Lower Receiver ohne Innenteile solo, mattschwarz	<b>264,90</b>
			
	AR06702	Yankee Hill Lower Receiver ohne Innenteile solo, mattschwarz	<b>269,90</b>
			
	AR06703	DPMS Lower Receiver AR-15 Parts Kit (alle Kleinteile für Griffstück)	<b>113,20</b>
	AR06704	Olympic Lower Receiver AR-15 Parts Kit (alle Kleinteile für Griffstück)	<b>144,80</b>
	AR06705	Daniel Defence Lower Receiver AR-15 Parts Kit (alle Kleinteile für Griffstück)	<b>149,90</b>
68	AR06806	DPMS Magazine Release, Chrome	<b>17,40</b>
	AR06807	DPMS Magazine Release, mattschwarz	<b>7,30</b>
	AR06808	DPMS Magazine Release Assembly, mattschwarz (Teil 68-70)	<b>11,90</b>
	AR06809	Olympic Magazine Release mattschwarz	<b>14,20</b>
69	AR06910	DPMS Magazine Release Button, mattschwarz	<b>3,70</b>
	AR06911	DPMS Magazine Release Button, matt Chrome	<b>12,50</b>
			
	AR06912	Model 1 Oversized Magazine Release Button, mattschwarz	<b>15,00</b>
	AR06913	Olympic Magazine Release Button, mattschwarz	<b>6,20</b>
			
	AR06914	Power Custom Oversize Magazine Release Button, mattschwarz	<b>29,70</b>
70	AR07015	DPMS Magazine Release Spring	<b>2,80</b>
	AR07016	Olympic Magazine Release Spring	<b>3,70</b>
71	AR07117	DPMS Crush Washer	<b>5,50</b>
	AR07118	DPMS Peel Washer	<b>5,70</b>
	AR07119	Olympic Crush Washer	<b>8,90</b>
			
72	AR07220	DPMS Pistol Grip Panther Style Synthetic, schwarz	<b>76,00</b>











# Zeichnung	Art.-Nr.	Beschreibung	Preis
	<b>AR07221</b>	DPMS Pistol Grip Synthetic, schwarz	<b>7,70</b>
			
	<b>AR07222</b>	Falcon Ind. ERGO Sure Grip Rubber, schwarz	<b>46,40</b>
	<b>AR07223</b>	Falcon Ind. ERGO Sure Grip Rubber, dark earth	<b>38,90</b>
	<b>AR07224</b>	Falcon Ind. ERGO Sure Grip Rubber, olive drab	<b>38,90</b>
	<b>AR07225</b>	Falcon Ind. ERGO Tactical Deluxe Sure Grip Rubber, schwarz	<b>57,80</b>
	<b>AR07226</b>	Falcon Ind. ERGO Tactical Deluxe Sure Grip Rubber, dark earth	<b>57,80</b>
			
	<b>AR07227</b>	Falcon Ind. ERGO Tactical Deluxe Sure Grip Rubber, olive drab	<b>57,80</b>
			
	<b>AR07228</b>	Hogue Over Molded Pistol Grip Rubber, schwarz	<b>36,80</b>
			
	<b>AR07229</b>	Hogue Over Molded Pistol Grip mit Samson Field Survivor Kit, schwarz	<b>199,90</b>
	<b>AR07230</b>	MagPul MIAD Modular Pistol Grip Kit Synthetic, schwarz	<b>49,90</b>
			
	<b>AR07231</b>	MagPul MIAD Modular Pistol Grip Kit Synthetic, dark earth	<b>49,90</b>
	<b>AR07232</b>	MagPul MIAD Modular Pistol Grip Kit Synthetic, Olive Drab	<b>49,90</b>
			
	<b>AR07233</b>	MagPul MIAD Modular Pistol Grip Kit Synthetic, Foliage Green	<b>49,90</b>
73	<b>AR07334</b>	DPMS Pistol Grip Screw Lock Washer	<b>3,10</b>
	<b>AR07335</b>	Olympic Pistol Grip Screw Lock Washer	<b>3,50</b>
74	<b>AR07436</b>	DPMS Pistol Grip Screw	<b>3,20</b>
	<b>AR07437</b>	Olympic Pistol Grip Screw	<b>5,20</b>
75	<b>AR07538</b>	DPMS Pivot Pin 0.250", mattschwarz	<b>8,30</b>
	<b>AR07539</b>	DPMS Quick Takedown Pivot Pin 0.250", mattschwarz	<b>12,10</b>

# Zeichnung	Art.-Nr.	Beschreibung	Preis
	<b>AR07540</b>	DPMS Quick Takedown Pivot Pin 0.312", mattschwarz	<b>14,90</b>
76	<b>AR07641</b>	Olympic Rear Sight Base Lug A2, mattschwarz	<b>21,90</b>
77	<b>AR07742</b>	DPMS Rear Sight 0.046" Aperture National Match-Style, mattschwarz	<b>16,20</b>
	<b>AR07743</b>	DPMS Rear Sight 0.052" Aperture National Match-Style, mattschwarz	<b>16,20</b>
	<b>AR07744</b>	DPMS Rear Sight Aperture National, mattschwarz	<b>15,60</b>
	<b>AR07745</b>	DPMS Rear Sight Aperture National, mattschwarz	<b>17,40</b>
			
	<b>AR07746</b>	XS CSAT Combat Rear Sight Aperture A2, mattschwarz	<b>56,30</b>
78	<b>AR07847</b>	DPMS Rear Sight Base Ball Bearing	<b>3,00</b>
	<b>AR07848</b>	Olympic Rear Sight Detent	<b>3,40</b>
79	<b>AR07949</b>	DPMS Rear Sight Base Elevation Index A2, mattschwarz	<b>12,90</b>
	<b>AR07950</b>	Olympic Rear Sight Base Elevation Index A2, mattschwarz	<b>10,50</b>
80	<b>AR08051</b>	DPMS Rear Sight Base Elevation Knob A2, mattschwarz	<b>12,30</b>
	<b>AR08052</b>	Olympic Rear Sight Base Elevation Knob A2, mattschwarz	<b>10,50</b>
81	<b>AR08153</b>	DPMS Rear Sight Base Elevation Knob Spring A2	<b>3,00</b>
82	<b>AR08254</b>	DPMS Rear Sight Base Flat Spring A2	<b>3,50</b>
	<b>AR08255</b>	Olympic Rear Sight Base Flat Spring A1	<b>3,50</b>
83	<b>AR08356</b>	DPMS Rear Sight Base Index Screw A2, mattschwarz	<b>3,50</b>
	<b>AR08357</b>	Olympic Rear Sight Base Index Screw A2, mattschwarz	<b>3,50</b>
84	<b>AR08458</b>	DPMS Rear Sight Base Spring A2	<b>3,20</b>
	<b>AR08459</b>	Olympic Rear Sight Base Spring A2	<b>3,20</b>
85	<b>AR08560</b>	DPMS Rear Sight Base Spring Pin A2	<b>2,80</b>
	<b>AR08561</b>	Olympic Rear Sight Base Spring Pin A2	<b>3,30</b>
	<b>AR08562</b>	Olympic Rear Sight Windage Drum Roll Pin A1	<b>3,50</b>
	<b>AR08563</b>	Olympic Rear Sight Windage Knob Roll Pin A"	<b>3,50</b>
			
86	<b>AR08664</b>	DPMS Rear Sight Base Windage Knob A2, mattschwarz	<b>12,30</b>
			
	<b>AR08665</b>	DPMS Rear Sight Windage Drum A1, mattschwarz	<b>5,10</b>
	<b>AR08666</b>	Olympic Rear Sight Base Windage Knob A2, mattschwarz	<b>12,50</b>
	<b>AR08667</b>	Olympic Rear Sight Windage Drum A1, mattschwarz	<b>12,50</b>
87	<b>AR08768</b>	DPMS Rear Sight Base Windage Knob Screw A2, mattschwarz	<b>5,30</b>

# Zeichnung	Art.-Nr.	Beschreibung	Preis
	<b>AR08769</b>	DPMS Rear Sight Base Windage Knob Screw A1, mattschwarz	<b>6,70</b>
	<b>AR08770</b>	Olympic Rear Sight Base Windage Knob Screw A2, mattschwarz	<b>6,30</b>
			
88	<b>AR08871</b>	Daniel Defense Burnsed Loop Sling Mount Adapter A2, mattschwarz	<b>58,40</b>
	<b>AR08872</b>	Daniel Defense Burnsed Loop Sling Mount Adapter A1, mattschwarz	<b>58,40</b>
			
	<b>AR08873</b>	DPMS Rear Sling Swivel A2	<b>5,80</b>
89	<b>AR08974</b>	DPMS Safety Selector, mattschwarz	<b>21,90</b>
	<b>AR08975</b>	DPMS Safety Selector, Chrome	<b>21,20</b>
	<b>AR08976</b>	DPMS Safety Selector, TiN Coated	<b>33,90</b>
			
	<b>AR08977</b>	Badger Ordnance Universal Safety Selector, mattschwarz	<b>79,80</b>
90	<b>AR09078</b>	DPMS Safety Selector Detent	<b>3,20</b>
	<b>AR09079</b>	Olympic Safety Selector Detent	<b>3,70</b>
91	<b>AR09180</b>	DPMS Safety Selector Dentent	<b>2,90</b>
	<b>AR09181</b>	Olympic Safety Selector Detent Spring	<b>3,50</b>
92	<b>AR09282</b>	DPMS Takedown and Pivot Pin Detent	<b>3,20</b>
	<b>AR09283</b>	Olympic Takedown and Pivot Pin Detent	<b>3,50</b>
93	<b>AR09384</b>	DPMS Takedown and Pivot Pin Detent Spring	<b>2,80</b>
	<b>AR09385</b>	Olympic Takedown and Pivot Pin Detent Spring	<b>3,50</b>
94	<b>AR09486</b>	DPMS Takedown Pin, Chrome	<b>19,00</b>
	<b>AR09487</b>	DPMS Takedown Pin, mattschwarz	<b>7,30</b>
			
95	<b>AR09588</b>	Alexander Arms Tactical Trigger Assembly small Pin 0.154", silver	<b>299,90</b>
			
	<b>AR09589</b>	DPMS Trigger Group small pin 0.154", mattschwarz	<b>79,90</b>
	<b>AR09590</b>	DPMS Trigger only large pin 0,170", mattschwarz	<b>92,80</b>
	<b>AR09591</b>	DPMS Trigger only small pin 0,154", mattschwarz	<b>22,90</b>
			
	<b>AR09592</b>	DPMS Trigger only small pin 0,154", TiN Coated	<b>51,60</b>

# Zeichnung	Art.-Nr.	Beschreibung	Preis
			
	<b>AR09593</b>	Jard Adjustable Trigger Small Pin 0,154" Single stage, schwarz (700g)	<b>249,00</b>
			
	<b>AR09594</b>	Jewell Trigger Assembly small pin 0,154" Two Stage, schwarz	<b>346,60</b>
			
	<b>AR09595</b>	Timney Trigger Small Pin 0.154" Single Stage Skeleton (1360g)	<b>359,00</b>
	<b>AR09596</b>	Timney Trigger Small Pin 0,154" Single Stage Skeleton (1800g)	<b>359,00</b>
			
	<b>AR09597</b>	Timney Trigger Small Pin 0,154" Single Stage Solid (1360g)	<b>278,00</b>
	<b>AR09598</b>	Timney Trigger Small Pin 0,154" Single Stage Solid (1800g)	<b>278,00</b>
96	<b>AR09699</b>	DPMS Trigger Guard Assembly mit Pin	<b>11,70</b>
	<b>AR09600</b>	MagPul MIAD Enhanced Trigger Guard, mattschwarz Alu	<b>26,20</b>
	<b>AR09601</b>	MagPul MIAD Enhanced Trigger Guard, mattschwarz Polymer	<b>12,60</b>
	<b>AR09602</b>	Olympic Trigger Guard mit Pin	<b>11,20</b>
97	<b>AR09703</b>	DPMS Trigger Guard Roll Pin	<b>3,00</b>
	<b>AR09704</b>	Olympic Trigger Guard Roll Pin	<b>3,50</b>
98	<b>AR09805</b>	DPMS Hammer and Trigger Pin small 0.154"	<b>7,10</b>
	<b>AR09806</b>	DPMS Hammer and Trigger Pin large 0.174"	<b>6,30</b>
			
	<b>AR09807</b>	DPMS Anti Walk Hammer and Trigger small Pin 0,154"	<b>12,95</b>
	<b>AR09808</b>	JP Enterprises Anti-Walk Trigger and Hammer small pin 0.154"	<b>16,95</b>
	<b>AR09809</b>	JP Enterprises Anti-Walk Trigger and Hammer large pin 0.174"	<b>15,90</b>
			
99	<b>AR09910</b>	DPMS Trigger Spring	<b>3,40</b>
	<b>AR09911</b>	JP Enterprises Trigger Spring Reduced Power	<b>16,80</b>
			
100	<b>AR10012</b>	Adams Arms Gas Pistol Upper Receiver Flattop, mattschwarz	<b>*249,00</b>

# Zeichnung	Art.-Nr.	Beschreibung	Preis
	AR10013	 Yankee Hill Upper Receiver Flattop, mattschwarz	<b>*249,00</b>
101	AR10114	 DPMS Delta Pack, mattschwarz	<b>16,30</b>
	AR10115	 DPMS Weld Spring	<b>10,20</b>
102	AR10216	Buffer Technologies Recoil Buffer Polyurethane	<b>15,80</b>
	AR10217	Buffer Technologies Endidine Hydraulic Recoil Buffer Carbine 3,25"	<b>171,90</b>
	AR10218	Buffer Technologies Endidine Hydraulic Recoil Buffer Rifle 5,8"	<b>189,80</b>
	AR10219	DPMS Accurizing Wedge	<b>9,20</b>
103	AR10320	DoubleStar Low Profile Gas Block Bull Barrel .936" Diameter	<b>64,00</b>
	AR10321	 DoubleStar Low Profile Gas Block Standard Barrel .750" Diameter	<b>56,80</b>
	AR10322	DoubleStar Low Profile Gas Block Lightweight Barrel .625" Diameter	<b>56,80</b>
	AR10323	 Double Star Gas Block Single Picatinny Rail Bull Barrel .936" Diameter	<b>47,80</b>
	AR10324	Double Star Gas Block Single Picatinny Rail Standard Barrel .750"	<b>47,80</b>
	AR10325	Double Star Gas Block Single Picatinny Rail Lightweight Barrel .625"	<b>47,80</b>
	AR10326	 JP Enterprises Adjustable Picatinny Rail Sight Mounting Gas Block Standard Barrel .750" Aluminium, mattschwarz	<b>107,70</b>
	AR10327	 JP Enterprises Adjustable Picatinny Rail Sight Mounting Gas Block Standard Barrel .750", Stainless Steel	<b>121,90</b>
	AR10328	JP Enterprises Adjustable Picatinny Rail Sight Mounting Gas Block Standard Barrel .936" Aluminium, mattschwarz	<b>121,90</b>
104	AR10429	MagPul Enhanced Self Leveling Magazine Follower, green, 3 Stück	<b>8,40</b>
	AR10430	MagPul Enhanced Self Leveling Magazine Follower, yellow, 3 Stück	<b>8,40</b>
106	AR10632	Arms G-Mag Magazin 10/20 Kunststoff	<b>25,00</b>
	AR10733	 Daniel Defense Offset Picatinny Rail	<b>65,90</b>

# Zeichnung	Art.-Nr.	Beschreibung	Preis
	AR10734	 Daniel Defencse Low Profile Picatinny Rail Cover 16,5 cm, schwarz, 3 Stück	<b>41,20</b>
	AR10735	 Falcon Industries Low Profile Picatinny Rail Cover 6,3 cm, schwarz, 3 Stück	<b>26,90</b>
	AR10736	 Falcon Industries Low Profile Picatinny Rail Cover 15,2cm, schwarz, 3 Stück	<b>53,90</b>
	AR10737	 MagPul XT Full Profile Pica. Rail Cover 16,5 cm ,schwarz	<b>15,90</b>
	AR10738	Mako Full Profile Rail Cover Short, schwarz, 3 Stück	<b>13,90</b>
	<b>Mako Hülsenfänger AR15</b> Passend für alle gängigen AR15-Systeme. Der Fänger wird über ein Klettsystem an der Waffe befestigt. Die im Nylonnetz gesammelten Hülsen können leicht über einen Reißverschluß entnommen werden.		
	AR10739	AR15 Hülsenfangsack	<b>20,40</b>
108	AR10839	 DPMS Rear Sight Assembly A2, mattschwarz	<b>69,90</b>
	AR10840	 DPMS Rear Sight National Match Style A2, mattschwarz	<b>147,90</b>
	AR10841	 MagPul MBUS Gen 2 Flip-up Front Sight Polymer, mattschwarz	<b>53,20</b>
	AR10842	 MagPul MBUS Gen 2 Flip-up Rear Sight Polymer, mattschwarz	<b>77,90</b>
	AR10843	 Midwest Industries Flip-up Front Sight Gas Block Alu, mattschwarz	<b>123,50</b>
	AR10844	 Midwest Industries Flip-up Rear Sight Flattop Alu, mattschwarz	<b>154,50</b>
	AR10845	 Yankee Hill QDS Flip-up Front and Rear Sight Set Alu, mattschwarz	<b>339,00</b>

# Zubehörteile AR-15

Art.-Nr. Beschreibung Preis

## Abdeckbuchse für Mündungsgewinde

AR20050 EGW Abdeckbuchse 1/2"-28, schwarz **26,90**



AR20051 Yankee Hill Abdeckbuchse 1/2"-28 für Standard-Lauf, schwarz **23,95**

AR20052 Yankee Hill Abdeckbuchse 1/2"-28 für Standard-Lauf, silber **23,95**

AR20053 Yankee Hill Abdeckbuchse 1/2"-28 für Bull-Lauf, schwarz **23,95**

AR20054 Yankee Hill Abdeckbuchse 1/2"-28 für Bull-Lauf, silber **23,95**

## Werkzeuge für AR-15



AR20155 AR-Stoner AR-15 Multi-Tool **49,80**

## Montageschlüssel für fast alle Verbindungen am AR-15



AR20156 AR-Stoner AR-15 Take Down Schlüssel **38,50**

## Montageschlüssel für die einfachen Arbeiten am AR-15



AR20157 DPMS Schaftschlüssel **49,90**

„The Flipper“ – DPMS Spannvorrichtung für Receiver von AR-15, AR-10, LR-308.

Der „Flipper“ ist eine einzigartige Spannvorrichtung, die den Upper oder Lower Receiver bei Reparatur- oder Installationsarbeiten festhält. Dabei wird eine Seite in den Magazinschacht des AR Lower Receivers eingesetzt und fungiert dann als sicherer Ansatzpunkt für Ihren Schraubstock. Wenn Sie die Spannvorrichtung umdrehen, lässt sie sich in den Upper Receiver einsetzen. Aus widerstandsfähigem Delrin-Material, das die Waffe dennoch nicht zerkratzt oder beschädigt.



AR20158 DPMS „Flipper“ Spannaufnahme für AR-15 **69,00**

AR20159 DPMS „Flipper“ Spannaufnahme für AR-10, LR308 **89,00**

Komplettsatz für die Wartung von AR-15-Gewehren. Das Set enthält: Schraubstock für Lower Receiver und Verschluss, 5-teiligen Stahlputzstock, Bronzelaufbürste Kaliber 22, Bronzepatronenlagerbürste Kaliber 22, Plastikreinigungsbürste, Ölflasche, 9 verschiedene Durchschläge, TL-A1-Schlüssel für Visiereinstellungen, Multitool-Schlüssel und Hakenschlüssel aus Stahl, Go- und No-go-Verschlussabstandslehren. Gepackt in einen Kunststoff-Werkzeugkasten mit herausnehmbarem Tablett.



AR20160 DPMS AR-15 Werkzeugkasten mit allem, was man für sein AR-15 braucht **399,00**

Art.-Nr. Beschreibung Preis



AR20161 Model 1 Satz mit 7 Durchschlägen für AR-15 **28,50**



AR20162 Mounting Solutions Schlüssel zur Verstellung des Korns mit 2 „Nasen“ **16,30**



AR20163 Tapco Schlüssel zur Verstellung des Korns mit 4 „Nasen“ **12,40**



AR20164 Schuster Schlüssel zur Korn- und Visierverstellung **49,90**

Picatinny Rail Adapter zum Anbau eines Zweibeins für AR-15 und alle Waffen, die eine Picatinny Rail unter dem Lauf / Vorderschaft haben



AR20265 FA Enterprises Picatinny Adapter **64,80**



AR20266 Olympic Picatinny Adapter **51,80**



AR20267 Yankee Hill Picatinny Adapter **51,80**

Picatinny Rail Adapter für Gewehrriemen









AR20368 Falcon Industries A2-Style Riemenbügelöse **36,80**



AR20369 Yankee Hill Riemenbügel Adapter **38,90**

Art.-Nr.	Beschreibung	Preis
	Senkrechter Griff für Picatinny Rail oder Weaver Rail für Lang- oder Kurzwaffe	
		
AR20470	MagPul MOE MVG für MOE Vorderschaft, schwarz	28,50
		
AR20471	MagPul MOE RVG, schwarz	39,40
		
AR20472	Promag Griff, schwarz	21,80
		
AR20473	MAKO Klappgriff, schwarz	59,90
		
AR20474	Yankee Hill Quick Action Klappgriff, schwarz	129,50
		
AR20475	Yankee Hill 3-Positionen Klappgriff	78,50
	Schräger Griff für Picatinny Rail für Langwaffen ermöglicht ein entspannteres Greifen der Waffe beim schnellen Anschlag	
		
AR20576	MagPul Angled Forend Grip schwarz	55,00
AR20577	MagPul Angled Forend Grip Dark Earth	55,00
AR20578	MagPul Angled Forend Grip Foliage Green	55,00
AR20579	MagPul Angled Forend Grip Olive Drab	55,00
	Arredondo extragroßer Magazinschacht für AR-15 Die schmal zulaufende Bauweise ermöglicht unglaublich schnellen Magazinwechsel, ohne dass das Ziel jemals aus den Augen gelassen werden muss. Aus sehr widerstandsfähigem Nylon. Schwarz.	
AR20989	Extragroßer Magazinschacht für AR-15	75,80

Art.-Nr.	Beschreibung	Preis
	<b>AR-15 Field Repair Kit</b> Viele Kleinteile, die beim AR-15 mal verschleiben können als Kit, damit die Waffe auf dem Schießstand gleich wieder „flott“ gemacht werden kann. Unter anderem sind enthalten, Schlagbolzen, Federn, Stifte, Gasringe, u.v.m.	
		
AR20680	Bushmaster Field Repair Kit	62,90
		
AR20681	DPMS Field Repair Kit Standard	48,90
		
AR20682	DPMS Ultimate Field Repair Kit	65,80
	<b>AR-15 Carry Handles mit A2 Rear Sight / Diopter</b>	
		
AR20783	DPMS Carry Handle	174,80
		
AR20784	Olympic Carry Handle	209,00
	<b>Blackhawk Cheek Rest für Gewehrschäfte</b> Hilft bei der Entlastung der Augen und mindert Rutschen und gefühlten Rückstoß an Hals und Wange. Die HawkTex-Modelle sind höhenverstellbar.	
AR20885	Blackhawk Cheek Rest	27,90
		
AR20886	Blackhawk Cheek Rest HawkTex	39,90
AR20888	Blackhawk Cheek Rest HawkTex AR-15	35,90
AR20887	IVS Cheek Rest mit 5-Schuss Munitionshalter	59,90
		
	<b>Patronenlagerbürste AR15</b> aus Bronze, Gewinde 8/32"	
VV40145	AR15	€ 4,50
VV40146	AR10	€ 6,70